



Luxer Lockers Specifications

Contact: sales@luxerone.com

L U X E R[®]
O N E

Indoor Locker Tower Specifications

1 of 3 (Continued on next page)

76" HIGH*



15-DOOR MAIN

- 15 doors.
- Touchscreen.
- Battery back-up.
- Surge protection and electronics.
- One main unit is required with every installation.

Weight: 500 lbs

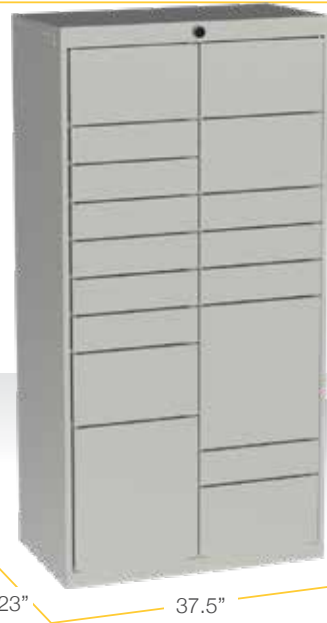

17-DOOR ADD-ON

- 2 large doors.
- 4 medium doors.
- 10 small doors.
- Add as many as you need.

Weight: 500 lbs



14-DOOR ADD-ON

- 14 medium doors.
- Add as many as you need.

Weight: 500 lbs



24-DOOR ADD-ON

- 4 medium doors.
- 20 small doors.
- Add as many as you need.

Weight: 500 lbs

* Upon leveling, height may change up to 3".

Indoor Locker Tower Specifications

2 of 3 (Continued from previous page)

76" HIGH*

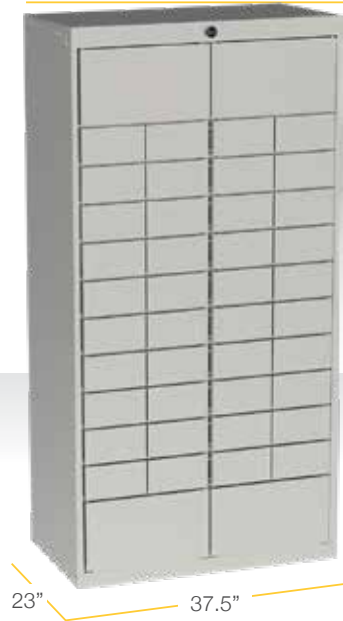

44-DOOR ADD-ON

- 40 extra-small doors.
- 4 medium doors.
- Add as many as you need.

Weight: 730 lbs

* Upon leveling, height may change up to 3".



4-DOOR ADD-ON

- 4 extra-tall doors.
- Add as many as you need.

Weight: 350 lbs



OVERSIZED

- 1 oversized door.
- Accepts 100% of parcels, including oversized and oddly-shaped packages.
- At least one of these units strongly recommended for every installation.

Weight: 270 lbs

Indoor Locker Tower Specifications

3 of 3 (Continued from previous page)

76" HIGH*



24.5" 27"

LUXER FRIDGE

- True Refrigeration® commercial refrigerator fully integrated with Luxer One system.
- Adjustable interior shelves.
- Add as many as you need.

Weight: 240 lbs



24.75" 29"

3-DOOR LUXER FRIDGE

- True Refrigeration® commercial refrigerator fully integrated with Luxer One system.
- Adjustable interior shelves.
- Add as many as you need.

Weight: 240 lbs

45" HIGH*



23" 37.5"

10-DOOR SIGHTLINE MAIN

- Touchscreen.
- 7 small doors.
- 3 medium doors.

Weight: 350 lbs



23" 37.5"

12-DOOR SIGHTLINE ADD-ON

- 8 small doors.
- 4 medium doors.
- Add as many as you need.

Weight: 350 lbs

* Upon leveling, height may change up to 3".

Outdoor Locker Tower Specifications

1 of 2 (Continued on next page)

89.5" HIGH*



15-DOOR MAIN

- 15 doors.
- Touchscreen.
- Battery back-up.
- Surge protection and electronics.
- One main unit is required with every installation.

Weight: 550 lbs



17-DOOR ADD-ON

- 2 large doors.
- 4 medium doors.
- 10 small doors.
- Add as many as you need.

Weight: 550 lbs



14-DOOR ADD-ON

- 14 medium doors.
- Add as many as you need.

Weight: 550 lbs



* Upon leveling, height may change up to 3".

Outdoor Locker Tower Specifications

2 of 2 (Continued from previous page)

89.5" HIGH*



OVERSIZED

- 1 oversized door.
- Accepts 100% of parcels, including oversized and oddly-shaped packages.
- At least one of these units strongly recommended for every installation.

Weight: 320 lbs



4-DOOR ADD-ON

- 4 extra-tall doors.
- Add as many as you need.

Weight: 400 lbs



24-DOOR ADD-ON

- 4 medium doors.
- 20 small doors.
- Add as many as you need.

Weight: 400 lbs



* Upon leveling, height may change up to 3".

Locker Compartment Dimensions

OVERSIZED

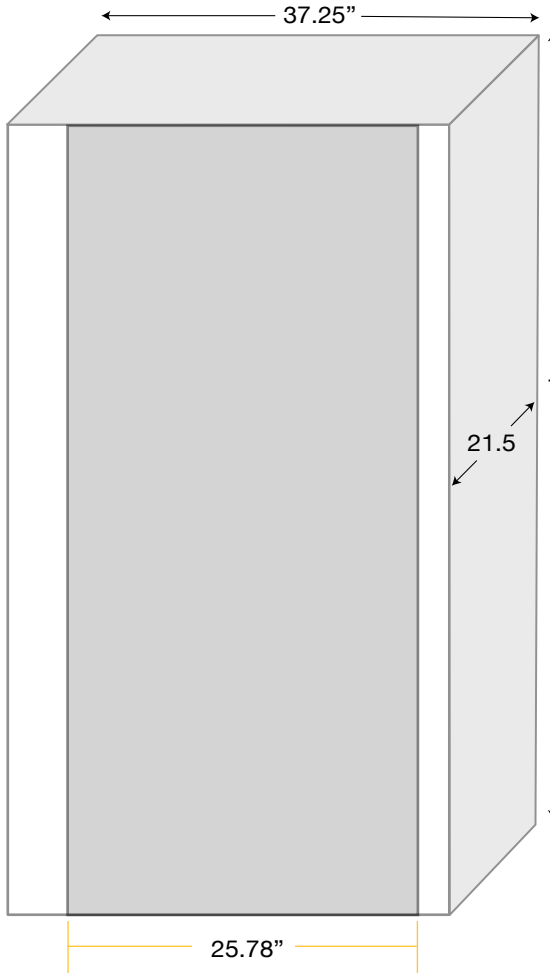

EXTRA-TALL

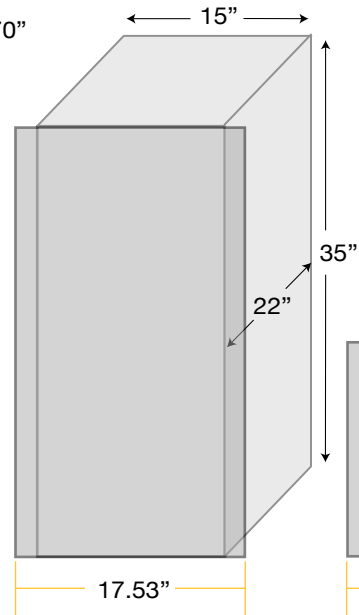

LARGE

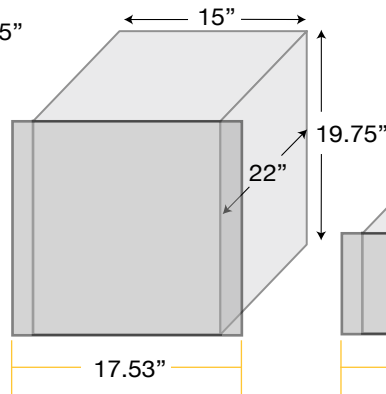

MEDIUM

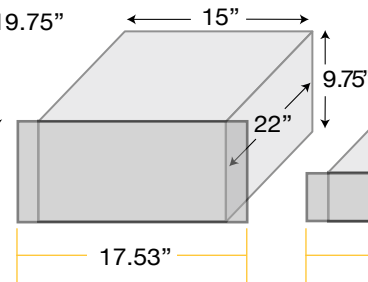

SMALL

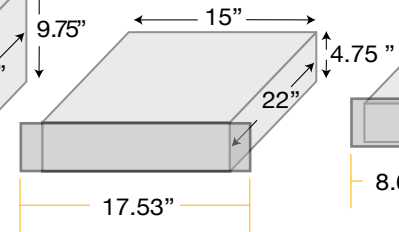

EXTRA SMALL

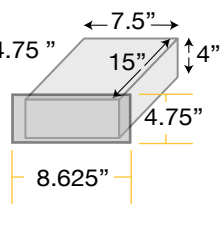

TECHNICAL SPECIFICATIONS



INDOOR LOCKERS



OUTDOOR LOCKERS

Leveling

Leveling feet

Leveling feet
Outdoor mounting brackets

Operating Temperature

41°F to 113°
(5°C to 45°C)

-4° to 113°F
(-20°C to 45°C)

Humidity

0-95% RH, non-condensing

Power Consumption

.4A nominal | 1A peak*
Luxer Fridge: 1.5A

.7A nominal
6.25 peak*

*Based on single row of up to 8 locker towers including Main

AC Voltage

Recommended: 120VAC
Minimum: 110VAC
50/60Hz nominal

Ethernet/Data

CAT6 with RJ45 jack
Minimum upload speed: 1.5MB
DHCP connection with open port preferred

Cellular option available as an alternative to Ethernet (outdoor only)

Indoor Lockers: Installation Requirements

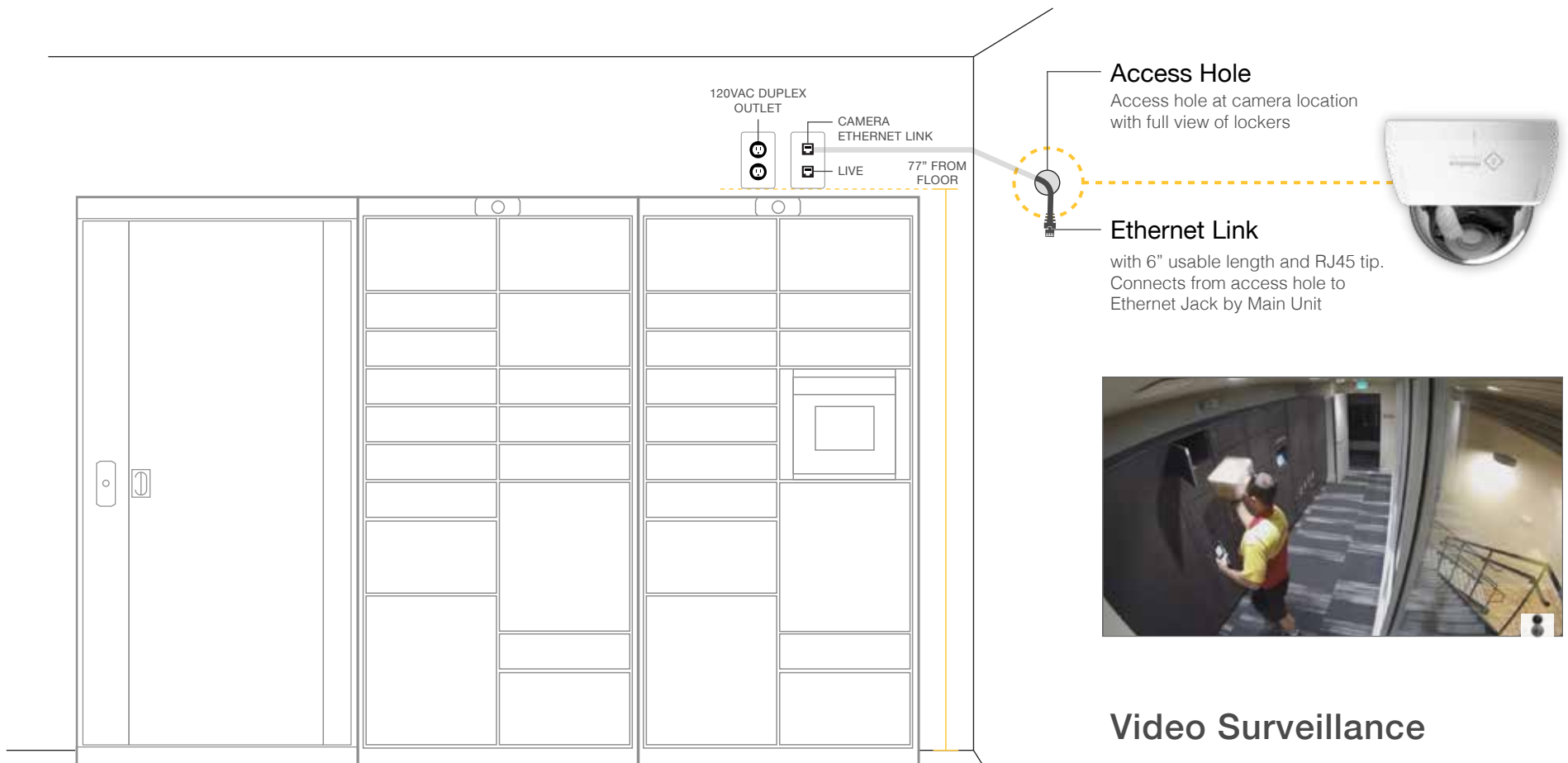

Power

- One (1) 120VAC duplex outlet above lockers.
- Bottom of power outlet at 77" from floor.

Live Data

- Ethernet jack wall plate.
- Minimum upload speed of 1.5M.
- Bottom of the ethernet jack wall plate at 77" from floor.
- DHCP connection.

Video Surveillance

Luxer One provides 24/7 video surveillance.

- One (1) surveillance camera is included. More may be required to capture full locker area.
- Footage is available for ten (10) days.
- Your team may request footage directly from your Luxer One Account Representative.

Indoor Lockers: Location Options

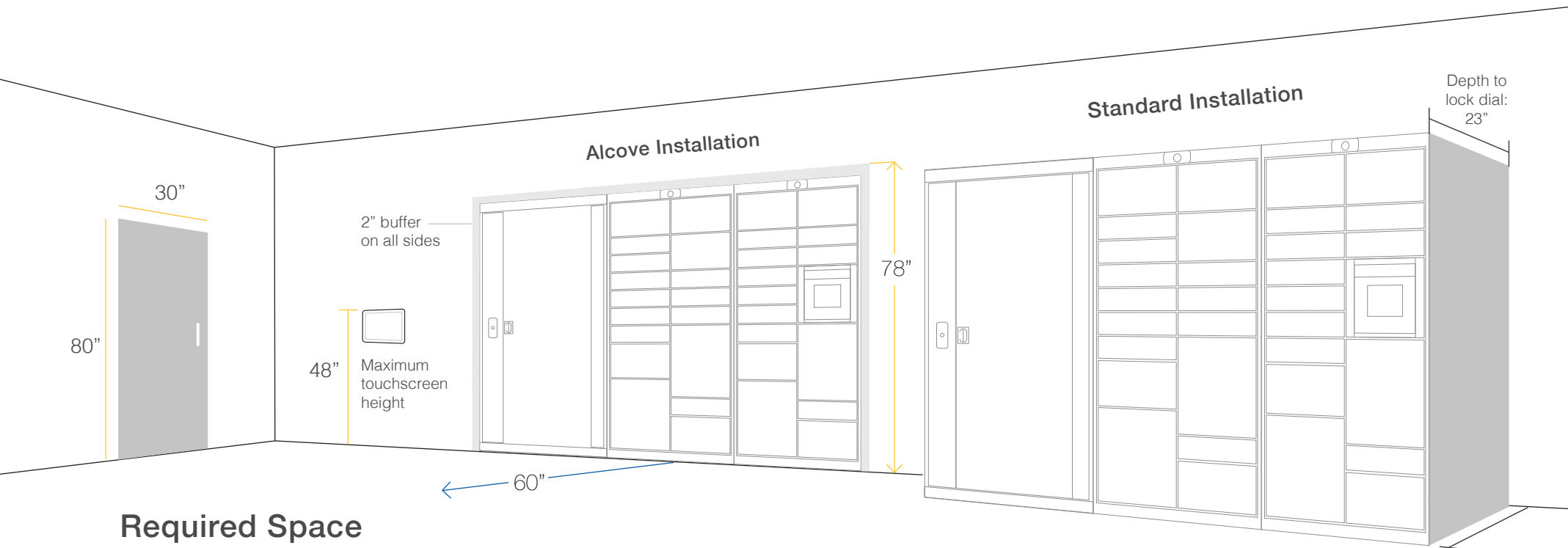

Required Space

- Minimum space in front of lockers: 60".
- Minimum entry space: 30" wide and 80" high.



In compliance with ADA/FHA guidelines.

Placement

- Lockers can be installed all along one wall, or separated against multiple walls.
- Lockers can also be embedded in a custom space, to appear flush against a wall.
- Optional trim pieces available.

Best Location

- Lockers must be in a location protected from the elements, with screen out of direct sunlight.
- Providing 24/7 locker access is recommended.

Touchscreens

- Luxer One allows for multiple screens, so recipients can pick up their package even while a delivery is being made.
- Standalone wall touchscreens require a power outlet and an ethernet link connection.

Indoor Lockers: Alcove Guidelines

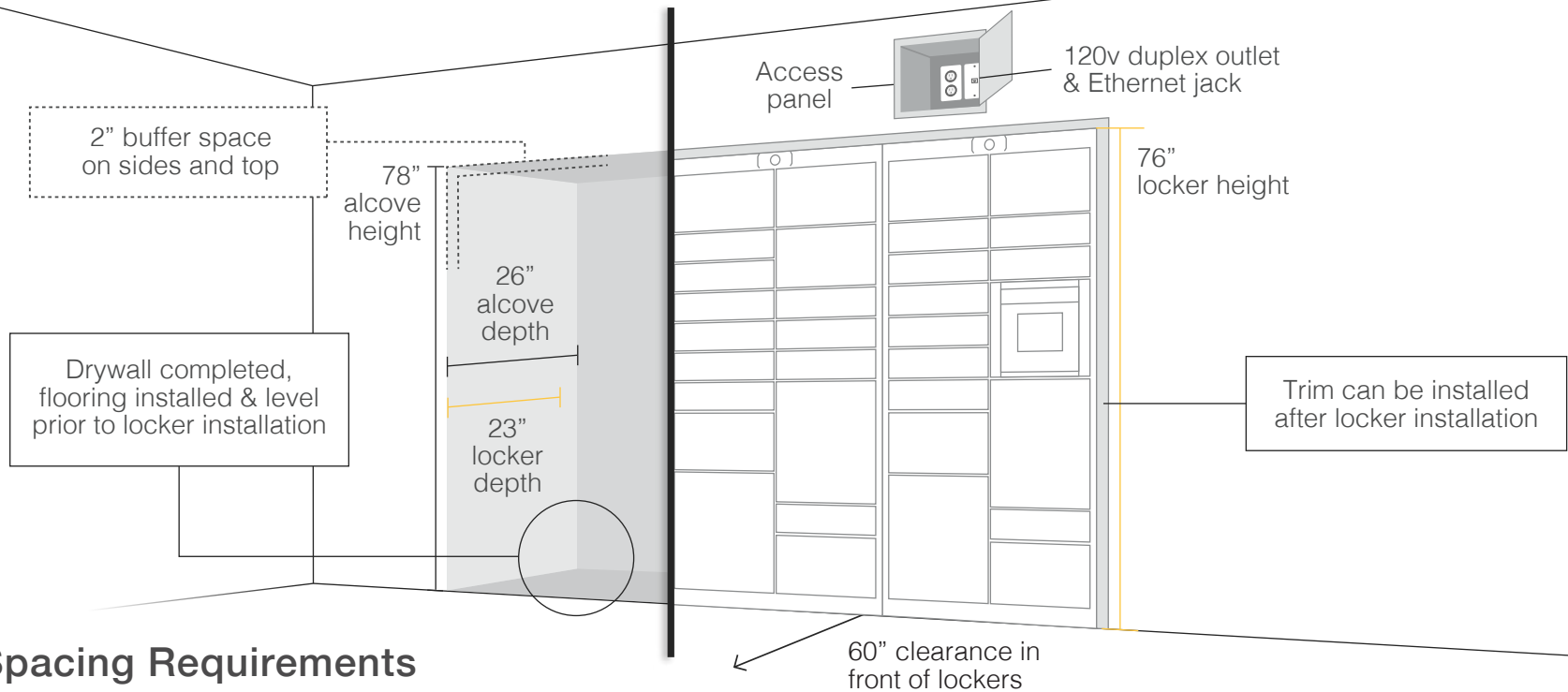

Alcove Spacing Requirements

Use these measurements to ensure that installation technician(s) have enough space to install and level the lockers.

- Height: Minimum 78" alcove height required. This accommodates 76" tall unlevelled lockers with a 2" buffer.
- Depth: Minimum 26" alcove depth required. This accommodates 23" deep lockers with a 3" buffer.
- Sides: Minimum 2" clearance on each side of locker bank required. Refer to locker floorplan for locker bank measurements.
- Buffer: The 2" buffer on the alcove top and sides must be 2" finished—drywall completed and flooring installed. Any remaining gap may be covered with trim by the property after locker installation.

Additional Alcove Guidelines

- Access panel: Install an access panel to allow future access to power & data. Recessed space behind access panel must be accessible from inside alcove & above lockers. Recommended placement is above the Main unit.
- Flooring: Alcoves should be level with the room's floor. Floor surface inside alcove must be leveled prior to installation.
- Floorplan: Note that your Luxer One floorplan will reflect finished dimensions, as opposed to rough openings.

Outdoor Lockers: What's Included



Roof Package

- Required for outdoor installs, unless located under an enclosed area.
- Protects unit from the elements.
- Provides mount for LED lights for nighttime illumination.
- Provides mount for surveillance cameras.



Electronics Package

- Protects the computer from extreme heat and cold.
- Seals the electronics bay contained in the main unit, and provides airflow and temperature modulation.

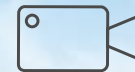

Camera Package

- Weather-proof outdoor-compliant camera.
- Mounts to roof package.



Outdoor Mounting Package

- Brackets included for anchoring towers to the concrete pad.
- Requires use of concrete anchors.

Please notify us if your installation site is located in an extreme weather region.

Outdoor Lockers: Installation Requirements

Power & Data

- Power: 120VAC, 50/60Hz from 20A electrical disconnect. Outdoor-rated #12 electrical wire run from an accessible outdoor-rated disconnect in 3/4" conduit. Electrician must be onsite to complete connectivity.
- Ethernet: Outdoor-rated CAT6 cable run in 3/4" conduit. Ethernet cable terminated with an RJ45 tip.
- Cellular connectivity option available as an alternative to ethernet.

Video Surveillance

Luxer One provides 24/7 video surveillance.

- One (1) surveillance camera is included.
- One camera needed for every four lockers.
- Footage is available for ten (10) days.
- Your team may request footage directly from your Luxer One Account Representative.

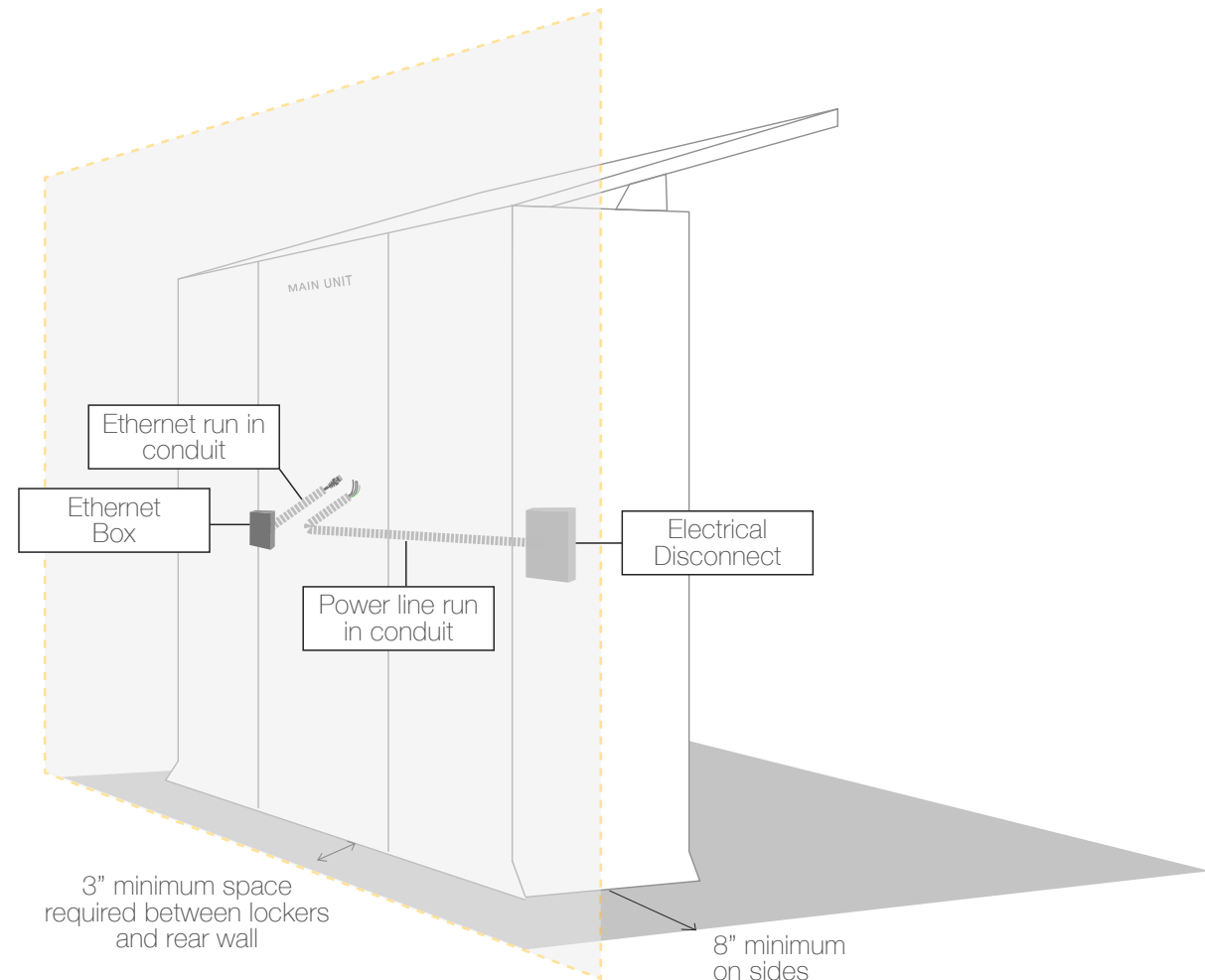

For illustrative purposes only. Refer to site-specific floorplan.

Outdoor Lockers: Location Options

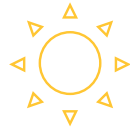

Place locker screen out of path of direct sunlight.

GRADED OPTION

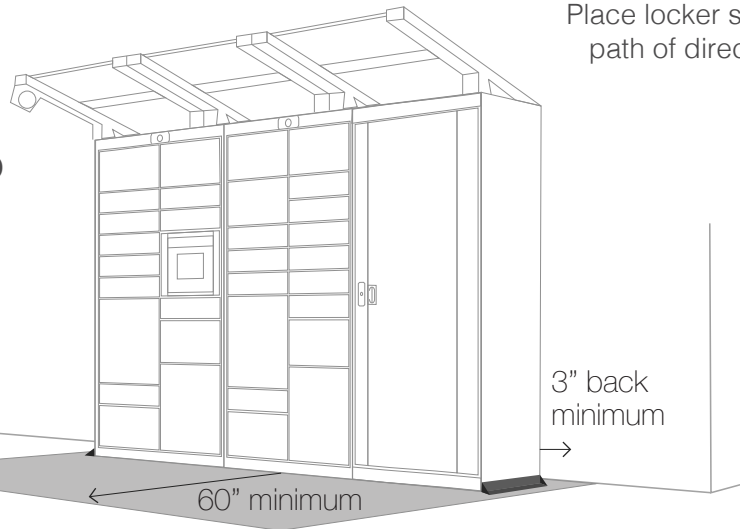

ABOVE GRADE OPTION

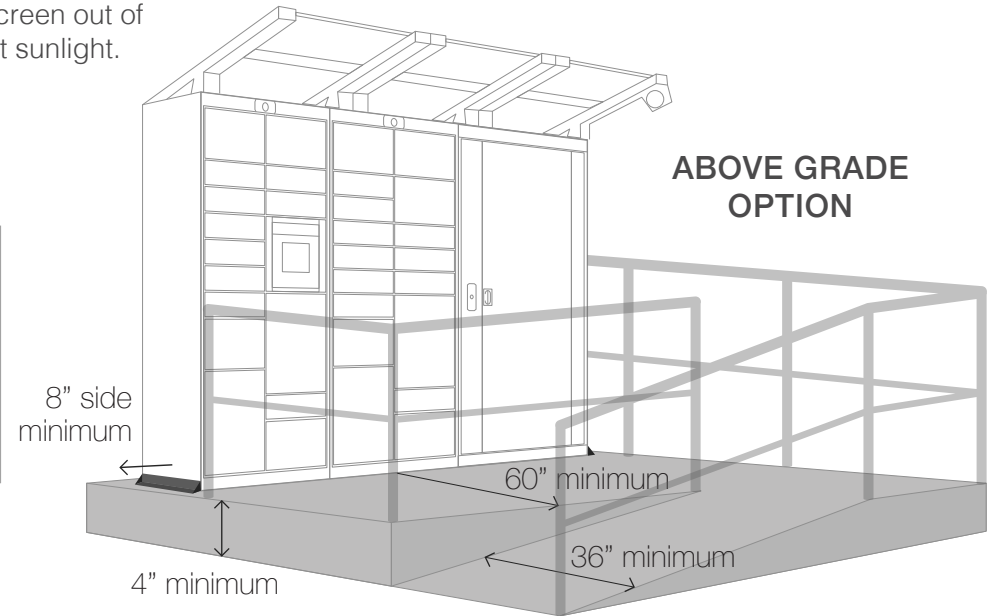

Concrete Pad Installation Requirements

- Sides: 8" required on each side of locker bank for mounting feet and anchors.
- Back: 3" required for power connections, network connectivity, and airflow.
- Front: Minimum of 60" of free space in front of lockers for ADA compliance.
- If above grade, ramp required for ADA accessibility.
- Maximum drainage slope of level pad not to exceed rise or fall of more than 1.5".

A concrete surface for mounting is required.

Locker Construction

Choose from four standard locker colors:



Superior Construction

- Heavy duty, corrosion-resistant steel for long-term durability.
- iPad-based touchscreens at ADA-compliant height.
- Battery back-up included in case of power outages.
- Web-based interface with extensive metrics reporting.
- Image capture of labels, signatures, and proof of pickup.
- Minimal Luxer One branding standard on all locker variations.

Go Bold!

Ask about trim pieces, custom colors, wraps, and adding your branding.

